

CHURRASQUEIRAS ROTATIVAS
COMPONENTES PARA CHURRASQUEIRAS ROTATIVAS
GANCHOS
GRELHAS, ESPETOS E ACESSÓRIOS
LINHA OUTDOOR
ACESSÓRIOS PARA LAREIRAS
COMPONENTES ELETRÔNICOS
ATUADORES LINEARES
MOTORREDUTORES
MOTORES
MOVIMENTAÇÃO DE CARGAS



CATÁLOGO
TRYREX



SOBRE A TRYREX

A Tryrex foi criada em 2012 com a missão de distribuir motores de corrente contínua no mercado brasileiro. Por se tratarem de produtos majoritariamente utilizados em sistemas gastronômicos automáticos como churrasqueiras rotativas, a empresa agregou ao seu portfólio sua linha inicial de grelhas e acessórios para churrasco em 2015.

Desenvolvendo sua ampla rede de clientes em 2018/19/20 a empresa também começou a se aventurar em outros campos, como a fabricação de componentes mecânicos e elétricos para churrasqueiras rotativas, sendo a líder neste mercado. Além disso, foi iniciada a expansão da linha dos artigos em aço, fabricando proteções aramadas e acessórios para lareiras.

Mais tarde, em 2021 a empresa criou sua marca, ATUAMEC, responsável pelo desenvolvimento, fabricação e distribuição de equipamentos para limpeza de painéis solares e outros. Hoje a ATUAMEC está presente em todo o Brasil e em mais 3 países, com diversos produtos patenteados. Veja mais em www.atuamec.com.br.

No ano de 2022 e 2023 a Tryrex passou por grandes transformações. Expandindo exponencialmente sua fábrica e modernizando seus processos. Além disso, também foi explorando seu acervo de produtos, criando as linhas de atuadores elétricos lineares, equipamentos para movimentação de cargas e churrasqueiras e acessórios para camping e praia.

Hoje são fabricados e distribuídos milhares de produtos mensalmente, incluindo acessórios para churrasco, motores, atuadores, controladores, conversores, engrenagens e componentes, churrasqueiras, acessórios para lareira, proteções aramadas, equipamentos para limpeza, equipamentos para movimentação, entre muitos outros.

A Tryrex é uma empresa que veio para entregar produtos de qualidade àqueles que reconhecem o que é bom de fato.

*Diagramação e arte final:
Estúdio Darsie - darsie.com.br*

*Fotos: Freepik, Sandro Darsie, acervo da empresa.
Imagens são ilustrativas.*

*Os produtos e suas descrições poderão ser modificados ou atualizados
sem aviso prévio, conforme a necessidade da empresa ou do mercado.*



LINHA DE PRODUTOS

- 4 CHURRASQUEIRAS ROTATIVAS
- 5 COMPONENTES PARA CHURRASQUEIRAS ROTATIVAS
- 7 GANCHOS
- 7 GRELHAS, ESPETOS E ACESSÓRIOS
- 11 LINHA OUTDOOR
- 12 ACESSÓRIOS PARA LAREIRAS
- 13 COMPONENTES ELETRÔNICOS
- 15 ATUADORES LINEARES
- 16 MOTORREDUTORES
- 17 MOTORES
- 18 MOVIMENTAÇÃO DE CARGAS
- 19 SERVIÇOS ESPECIALIZADOS DA TRYREX

 TRYREX

CHURRASQUEIRAS ROTATIVAS

PARA REVENDA E DISTRIBUIÇÃO

FABRICAMOS COM
A SUA MARCA

TR 6030 A 6034 LINHA 2 EM 1

Para ter o prazer de toda sua churrasqueira com espetos rotativos ou grelha elevatória - ou até os dois ao mesmo tempo - a Linha 2 em 1 é o produto para você. Um produto que engloba os espetos rotativos e grelha elevatória automática no mesmo espaço, proporcionando a máxima experiência gastronômica.

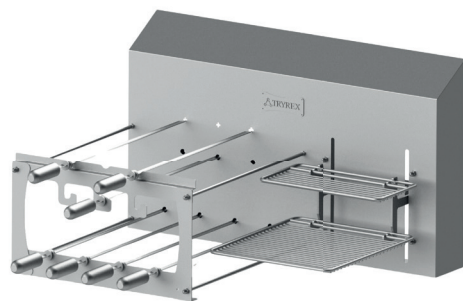
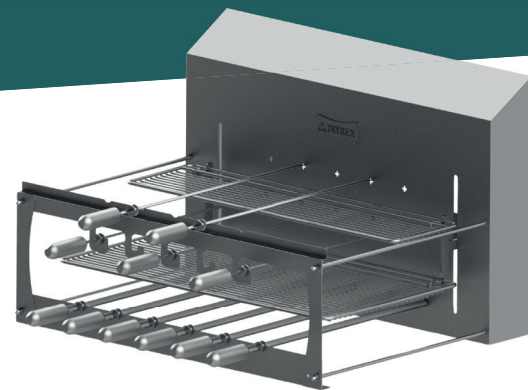

TR 6035 A 6039 LINHA DUETTO

Desenvolvida para aqueles que desejam ter uma área gourmet completa e automatizada, a Linha Duetto contempla o sistema de espetos rotativos ao lado do sistema de grelha elevatória elétrica. Esse modelo entrega uma ampla área para assar seu churrasco. Fabricado em aço inox 304, material premium e com acabamento perfeito.

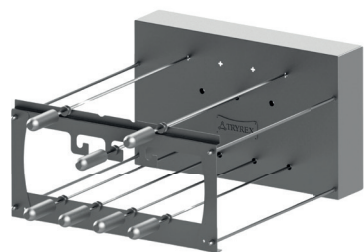

TR 6010 A 6015 LINHA SPLENDOR

Churrasqueiras de alto nível com acabamento excelente, confeccionadas sob-medida para cada cliente.

Construída em aço inox 304 escovado.

O pacote inclui controlador já conectado e espetos com cabos de madeira (possui opcional de espetos com cabos de inox escovado).

Além disso possui descanso para espetos e parte frontal removível.

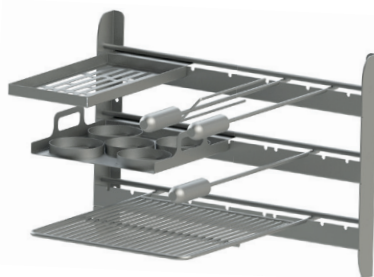

TR 6050 A 6055 LINHA SUSPENGRILL OPEN

Fabricado sob medida, foi desenvolvido pela Tryrex para atender todos clientes que amam churrasco, aliado a um visual minimalista.

Eficiente e durável, esta churrasqueira permite utilizar grelhas e espetos suspensos no ar com a comodidade de estarem apoiados apenas no fundo da churrasqueira.

Este produto é ideal para quem quer transformar seu ambiente gourmet com eficácia.



TR 6060 A 6065 LINHA SUSPENGRILL BOX

Fabricado sob medida foi pensado pela Tryrex para aqueles que adoram um bom churrasco mas também, prezam pela simplicidade.

Uma churrasqueira versátil, não motorizada, que permite a utilização de espetos e grelhas suspensos no ar, apenas apoiados no fundo da churrasqueira. O modelo BOX é personalizável e seu diferencial é ser totalmente fechado, apresentando visual moderno.

COMPONENTES PARA CHURRASQUEIRAS ROTATIVAS

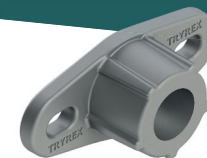

TR 801

Engrenagem de alumínio 29D
Ø 122 x Ø 12 x 16 x 10 mm

TR 802

Engrenagem de alumínio 29D
Ø 122 x Ø 12 x 28,5 x 10 mm

TR 803

Engrenagem de alumínio 37D
Ø 154 x Ø 12 x 16 x 10 mm

TR 804

Engrenagem de alumínio 37D
Ø 154 x Ø 12 x 28,5 x 10 mm

TR 805

Engrenagem de alumínio 18D
Ø 78 x Ø 12 x 16 x 10 mm

TR 806

Mancal
Ø 14,28 x 65 (largura) x 22 (altura)



TR 808

Kit engrenagem 29D
+ mancal + eixo completo

TR 809

Kit engrenagem 37D
+ mancal + eixo completo

TR 810

Kit engrenagem 29D
para montagem entre chapas

TR 811

Kit engrenagem 37D
para montagem entre chapas

TR 812

Kit engrenagem 29D
com duplo mancal

TR 813

Kit engrenagem 37D
com duplo mancal

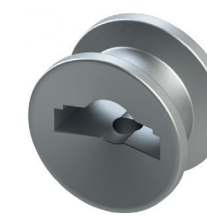
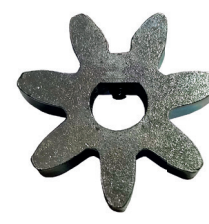
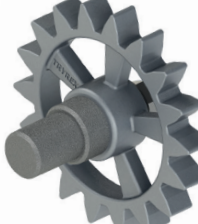

TR 816

Kit engrenagem 18D
para transmissão

TR 818

Kit engrenagem 18D
soldável para transmissão

TR 2011

Engrenagem de alumínio
53D Ø 8 x 222 mm

TR 2013

Engrenagem de alumínio
9D Ø 10 x 42 mm

TR 2014

Engrenagem de aço 1020
7D, espessura 10 mm
Ø 10 x 37 mm

TR 807

Roldana Universal
em Alumínio
para espeto

COMPONENTES PARA CHURRASQUEIRAS ROTATIVAS



TR 2015

Engrenagem de aço 1020
8D, espessura 8 mm
Ø 10 x 42 mm



TR 2016

Engrenagem de aço 1020
7D, espessura 6,35 mm
Ø 10 x 33 mm, asa 40/1



TR 2017

Engrenagem de aço 1020
11D, espessura 6,35 mm
Ø 10 x 50 mm, asa 40/1



TR 2018

Engrenagem inox 13D
espessura 2 mm
Ø 12 x 58,50 mm, asa 40/1



TR 2019

Engrenagem inox 13D
espessura 1,50 mm
furo meia lua
Ø 17 x 58,50 mm, asa 40/1



TR 2020

Engrenagem aço 1045 7D
espessura 3 mm
Ø 10 x 35,20 mm, asa 40/1



TR 2022

Engrenagem com
eixo 10 mm, gear box
para motorreductor pm 62



TR 2024

Eixo em latão para
engrenagem TR 2009



TR 2025

Corrente em aço inox
asa 40/1



TR 2026

Corrente em aço
carbono, asa 40/1



TR 2027

Emenda em aço carbono
para corrente 40/1



TR 2028

Emenda em aço inox
para corrente 40/1



TR 2030

Kit engrenagem para
espelho
15D x 4,7 x 68 mm, eixo
9,52 x 25 mm, furo 4 mm



TR 2031

Mancal em aço inox
para engrenagem



TR 3064

Cabo de inox
Ø 32 x 125 mm
furo 8,50 mm



TR 3098

Cabo de alumínio
32 x 140 mm



TR 3099

Cabo de madeira com
verniz em mogno
33 x 152 mm



TR 3107

Cabo de madeira
para espeto
35 x 150 mm

GANCHOS

GRELHAS, ESPETOS E ACESSÓRIOS

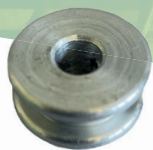

TR 3097

Roldana em alumínio
para espeto
8 mm

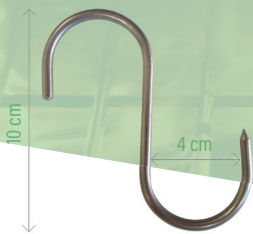

TR 3075

Gancho inox para
açougue S0 Ø 4,76 mm
3/16' 10kg



TR 3076

Gancho inox para
açougue S1 Ø 4,76 mm
3/16' 10kg

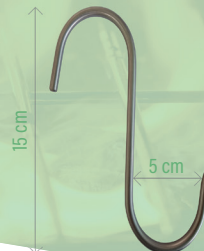

TR 3078

Gancho inox para
açougue S2 Ø 6,35 mm
1/4' 40kg



TR 3079

Gancho inox para
açougue S4 Ø 7,93 mm
5/16' 120kg



TR 3080

Gancho inox para
açougue S5 Ø 9,52 mm
3/8' 200kg



TR 3081

Gancho inox para
açougue S6 Ø 12,7 mm
1/2' 400kg



TR 3082

Gancho inox giratório
para açougue S6
Ø 12,7 mm 1/2' 300kg



TR 3083

Gancho inox giratório
para açougue V S6
Ø 12,7 mm 1/2' 300kg



TR 3084

Gancho inox central
para desossa
Ø 5,5 mm x 13 cm



TR 3000

Grelha inox cilíndrica
Linha Premium
Ø 100 x 270 mm



TR 3001

Grelha inox cilíndrica
Linha Premium
Ø 100 x 380 mm
simples

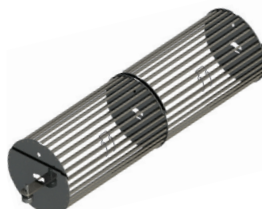

TR 3002

Grelha inox cilíndrica
Linha Premium
Ø 100 x 380 mm
dupla



TR 3003

Grelha inox cilíndrica com
acabamento eletrolítico
Ø 100 x 270 mm



TR 3004

Grelha inox cilíndrica
Ø 100 x 270 mm



TR 3005

Grelha inox cilíndrica
Ø 100 x 380 mm

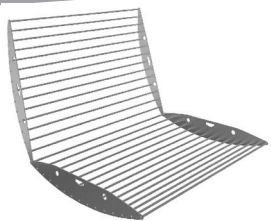

TR 3006

Grelha inox para carnes e peixes
380 x 274 x 50 mm

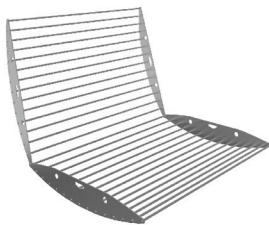

TR 3007

Grelha inox para carnes e peixes
440 x 274 x 50 mm



TR 3008

Grelha inox para carnes e peixes
380 x 274 x 50 mm
com cabo



TR 3009

Grelha inox para carnes e peixes
440 x 274 x 50 mm
com cabo



TR 3009

Grelha inox para carnes e peixes
440 x 274 x 50 mm
com cabo



TR 3010

Grelha inox para carnes, peixes e pão
385 x 140 x 60 mm
com cabo



TR 3011

Grelha inox dupla para carnes, peixes e pão
350 x 135 x 55 mm



TR 3012

Grelha inox simples para carnes, peixes e pão
350 x 135 x 55 mm



TR 3101

Grelha inox para costela, carnes e peixes
440 x 350 x 60 mm



TR 3013

Garfo inox quádruplo para espeto
440 x 75 x 5 mm



TR 3014

Garfo inox duplo para espeto
400 x 75 x 5 mm



TR 3015

Pegador inox para carnes
430 mm



TR 3016

Pegador inox para carnes
550 mm



TR 3017

Grelha inox para queijo
43 x 50 x 400 mm



TR 3018

Grelha inox para queijo
43 x 50 x 300 mm



TR 3019

Garfo inox curvo duplo para espeto
400 x 75 x 5 mm



TR 3020

Grelha inox com bordas
400 x 410
comprimento 770 mm
4,76 x 7,92 mm



TR 3021

Grelha inox com bordas
400 x 410
comprimento 770 mm
4,20 x 6,35 mm



TR 3022

Grelha inox para churrasco, rebaixada
400 x 400
comprimento 770 mm
2 x 6,35 mm



TR 3023

Grelha inox para hamburger 4 posições
400 x 400
280 x 285 mm



TR 3024

Grelha inox parilla argentina com coletor
420 x 420
comprimento 770 mm
1,2 x 7,92 mm



TR 3025

Grelha inox parilla argentina
420 x 420
comprimento 770 mm
1,2 x 7,92 mm



TR 3026

Grelha inox parilla argentina com coletor
420 x 500
comprimento 830 mm
1,2 x 7,92 mm



TR 3027

Grelha inox parilla argentina
420 x 500
comprimento 830 mm
1,2 x 7,92 mm



TR 3028

Grelha inox parilla argentina
520 x 500
comprimento 830 mm
1,2 x 7,92 mm



TR 3029

Grelha inox para pão
50 x 180 x 300 mm



TR 3103

Grelha inox premium para pão com eletropolimento
50 x 180 x 300 mm



TR 3031

Suporte para espetos (18 espetos)
2 x 150 x 320 mm



TR 3033

Grelha inox aramado
5 x 340 x 420 mm



TR 3034

Grelha giratória 360°
8 posições
550 x 390 mm



TR 3035

Grelha giratória 360°
8 posições
500 x 420 mm



TR 3036

Grelha giratória 360°
8 posições
550 x 490 mm



TR 3037

Grelha inox aramado
5 x 210 x 410 mm



TR 3038

Grelha inox aramado para costela
5 x 400 x 450 mm



TR 3043

Suporte inox aramado para espeto (21 espetos)
3,2 x 100 x 300 mm



TR 3044

Garfo multiuso
600 mm



TR 3053

Espeto giratório 360°
para costela
1000 x 200 x 9,52 mm



TR 3061

Mexedor de brasas
para churrasqueira
6,35 x 800 mm



TR 3062

Batedor de sal para
churrasco em inox
4,70 x 520 mm



TR 3068

Grelha inox para churrasco
20 x 255 x 440 mm
comprimento 670 mm
2 x 4,70 mm



TR 3069

Grelha inox para churrasco
20 x 300 x 520 mm
comprimento 760 mm
2 x 4,70 mm

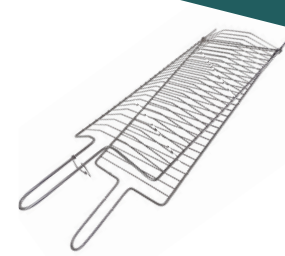

TR 3071

Grelha inox para churrasco
30 x 250 x 520 mm
comprimento 780 mm
2 x 4,70 mm

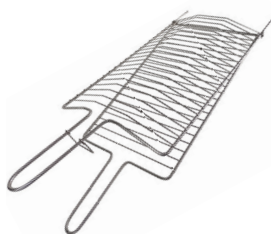

TR 3072

Grelha inox para churrasco
30 x 250 x 420 mm
comprimento 670 mm
2 x 4,70 mm



TR 3074

Grelha inox rebaixada
com encaixe para espetos
laterais
3 x 450 x 500 mm



TR 3087

Grelha inox rebaixada
com encaixe para espetos
laterais
3 x 400 x 440 mm

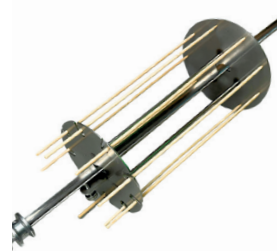

TR 3091

Suporte para espetinhos
de madeira
Ø 120 x 200 mm



TR 3105

Grelha cilíndrica slim
Ø 100 x 270 mm

ESPETOS

REF.	CABO	COMP. TOTAL	LÂMINA
TR 3047	Madeira	850 mm	1,5 x 17 x 700 mm
TR 3048	Madeira	950 mm	1,5 x 17 x 800 mm
TR 3049	Madeira	750 mm	1,5 x 17 x 600 mm
TR 3051	Madeira	850 mm	1,5 x 19 x 700 mm
TR 3052	Madeira	950 mm	1,5 x 19 x 800 mm
TR 3059	Madeira	850 mm	1,5 x 12 x 700 mm
TR 3055	Alumínio	850 mm	1,5 x 17 x 700 mm
TR 3056	Alumínio	950 mm	1,5 x 17 x 800 mm
TR 3065	Alumínio	850 mm	1,5 x 19 x 700 mm
TR 3066	Alumínio	950 mm	1,5 x 19 x 800 mm
TR 3063	Apenas lâmina	500/600/700/800mm	1,5x17x500/600/700/800mm

LINHA OUTDOOR

PARA REVENDA E DISTRIBUIÇÃO

FABRICAMOS COM
A SUA MARCA



TR 3310

Grelha vertical para
costelão de chão

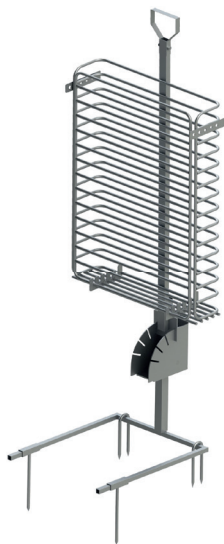

TR 3311

Grelha vertical multiângulos
para costelão



TR 3302

Churrasqueira
desmontável Flame Plus

Para garantir que sua atividade ao ar livre seja saborosa e prática, conheça nossa linha de produtos e equipamentos para churrasco ao ar livre.

As churrasqueiras desmontáveis garantem que você possa fazer seu assado com grelha e espetos em qualquer lugar com todo conforto e praticidade.

Nossas grelhas para costelão te mostram que o ato de fazer um assado para sua família, ou grupo de amigos, pode ser algo muito saboroso e divertido.



TR 3300

Churrasqueira
desmontável Smart



TR 3301

Churrasqueira
desmontável Flame



TR 3303

Churrasqueira
desmontável Smart Plus

PARA REVENDA E DISTRIBUIÇÃO

**FABRICAMOS COM
A SUA MARCA**

ACESSÓRIOS PARA LAREIRA

KITS PARA LIMPEZA E
CESTOS PARA LENHA



TR 3500

Kit limpeza para
lareira tubular
15x15



TR 3502

Kit limpeza
para lareira
aramado



TR 3505

Kit limpeza para
lareira, aramado,
em aço inox



TR 3506

Cesto porta lenha com
tela, côncavo
A 225 x L 460 x
C 350mm



TR 3507

Cesto para lenha tubular
15 x 15
A 300 x L 340 x
C 430mm



TR 3508

Cesto para lenha
aço 8mm
A 300 x L 340 x
C 430mm



TR 3509

Cesto para lenha
aramado em aço inox
A 300 x L 340 x
C 430mm



TR 3510

Cesto caixa para lenha
com cabo de madeira
A 300 x L 340 x
C 430mm



TR 3511

Cesto para lenha com
alça tubular 15x15mm
em aço inox 3mm
A 650 x L 340 x
C 430mm



TR 3512

Cesto para lenha
côncavo com chapa
A 225 x L 460 x
C 350mm



TR 3513

Cesto para lenha
com rodas e alça
regulável,
45 x 45 x 100 cm



TR 3515

Grelha interna
para lareira
sob medida



TR 35..

Suporte em aço para
fogueira ao ar livre

COMPONENTES ELETRÔNICOS



TR 1029

Conversor 220V para motorreductor 220 DC



TR 1030

Conversor 127V para motorreductor 127 DC



TR 1031

Conjunto de módulos p/ controle remoto de churrasqueira, grelha e lâmpada

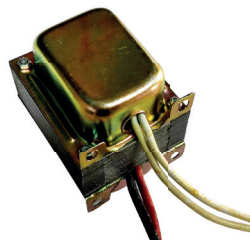

TR 1032

Fonte 220V / 24vcc 1,5 A

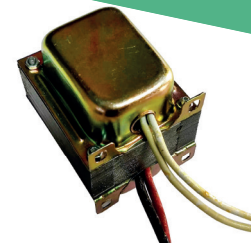

TR 1033

Fonte 220V / 12vcc 3 A



TR 1034

Fonte 220V / 24vcc 3 A caixa fixação, potenciômetro, LED e interruptor



TR 1035

Cabo plug inj 2 p+t 10A 1 metro



TR 1036

Prensa cabo rosca PG7 - preto



TR 1037

Ponte retificadora 25A 1000V

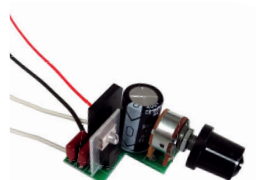

TR 1039

Controlador de motor DC 220V, potenciômetro acoplado para embutir



TR 1042

Comando para grelha e churrasqueira, acoplado, branco

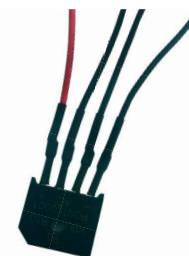

TR 1043

Ponte retificadora 8A 1000V

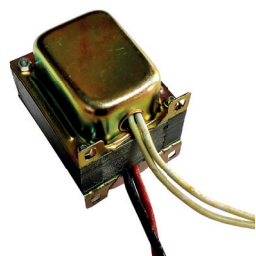

TR 1044

Fonte 127V / 12vcc 3A

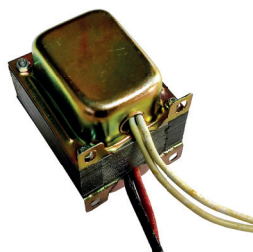

TR 1045

Fonte 127V / 24vcc 1,5A



TR 1046

Controlador de motor DC 220V, potenciômetro com cabo 10 cm



TR 1019

Controlador dimmer bivolt com regulagem, velocidade para 12/24V



TR 1020

Controlador de motor DC 220V com potenciômetro acoplado



TR 1021

Chave de pulso 6A com ponte retificadora acoplada

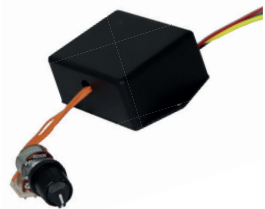

TR 1022

Controlador de motor
DC 127V, potenciômetro
com cabo 10 cm



TR 1067

Controlador 220vcc com
potenciômetro acoplado



TR 1023

Controlador de motor
DC 220V, LED,
potenciômetro acoplado



TR 1024

Controlador de motor
DC 127V, LED,
potenciômetro acoplado

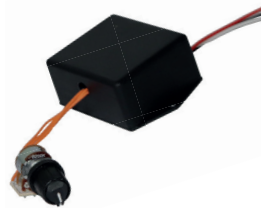

TR 1025

Controlador de motor
DC 220V, potenciômetro,
cabo 10 cm



TR 1028

Chave de pulso 15A
com ponte retificadora
acoplada e
caixa branca



TR 1066

Controlador 24vcc com
potenciômetro acoplado

FABRICAMOS NOSSOS SISTEMAS ELETRÔNICOS



TRYREX

ATUADORES LINEARES COMPACTOS

OS ATUADORES LINEARES COMPACTOS DA TRYREX FORAM DESENVOLVIDOS PARA AUXILIAR NA MOVIMENTAÇÃO E ATUAÇÃO DE DIVERSOS MECANISMOS E MAQUINÁRIOS.



PARA CARGA ATÉ 600 QUILOS

CARACTERÍSTICAS

**PATENTE REQUERIDA
BR 20 2022 0195906;**

- Disponível nas tensões de entrada 12V, 24V, 110V E 220V;
- Corrente contínua (acompanha controlador com ponte retificadora);
- Comprimento variável;
- Velocidade variável;
- Possui interruptor micro-fim-de-curso mecânico interno;
- Corpo construído em alumínio;
- Ponteiros articuladores em aço.



ATUADORES LINEARES PARA ALTAS CARGAS

PARA CARGA ATÉ 2 TONELADAS

MOTORREDUTORES E MOTORES



AT 1000

Motorreductor ímã permanente 220vcc
70 RPM, 55W
eixo 10 x 25 mm chanfrado



AT 1001

Motorreductor ímã permanente 127vcc
70 RPM, 60W
eixo 10 x 25 mm chanfrado



AT 1002

Motorreductor ímã permanente 24vcc
55 RPM, 55W
eixo 10 x 25 mm chanfrado



AT 1003

Motorreductor ímã permanente 12vcc
27 RPM, 28W
eixo 10 x 25 mm chanfrado



AT 1010

Motorreductor ímã permanente 220vcc
70 RPM, 55W
eixo 10 x 25 mm liso



AT 1011

Motorreductor ímã permanente 127vcc
70 RPM, 60W
eixo 10 x 55 mm liso



AT 1012

Motorreductor ímã permanente 24vcc
55 RPM, 55W
eixo 10 x 55 mm liso



AT 1013

Motorreductor ímã permanente 12vcc
27 RPM, 28W
eixo 10 x 55 mm liso



AT 1020

Motorreductor ímã permanente 220vcc
70 RPM, 55W
eixo 12 x 25 mm chanfrado



AT 1021

Motorreductor ímã permanente 127vcc
70 RPM, 60W
eixo 12 x 25 mm chanfrado



AT 1022

Motorreductor ímã permanente 24vcc
55 RPM, 55W
eixo 12 x 25 mm chanfrado



AT 1023

Motorreductor ímã permanente 12vcc
27 RPM, 28W
eixo 12 x 25 mm chanfrado



AT 1030

Motorreductor ímã permanente 220vcc
70 RPM, 55W
eixo 12 x 55 mm liso



AT 1031

Motorreductor ímã permanente 127vcc
70 RPM, 60W
eixo 12 x 55 mm liso



AT 1032

Motorreductor ímã permanente 24vcc
55 RPM, 55W
eixo 12 x 55 mm liso



AT 1033

Motorreductor ímã permanente 12vcc
27 RPM, 28W
eixo 12 x 55 mm liso



TR 1000

Motorreductor ímã permanente PM 62 GB S1
220vcc
70 RPM, 55W



TR 1001

Motorreductor ímã permanente PM 62 GB S1
127vcc
70 RPM, 60W



TR 1002

Motorreductor imã permanente PM 62 GB S1
24vcc
55 RPM, 46W



TR 1003

Motorreductor imã permanente PM 62 GB S1
12vcc
60 RPM, 50W



TR 1005

Motor PM 70 150vcc 3A
1.6 HP 6500 RPM



TR 1009

Motor imã permanente
127V 1000W 6500 RPM
Ø 77,30ccw



TR 1009

Motor imã permanente
127V 1000W 6500 RPM
Ø 77,30ccw



TR 1012

Motorreductor 1/5cv monofásico 220/254V 0,5A
30 RPM 11Nm



TR 1013

Motor imã permanente
220V 1000W 6500 RPM
Ø 77,30ccw



TR 1015

Motorreductor 18 RPM
redução 3 x 1 (motor +
chave elétrica e redutor)



TR 1040

Motor imã permanente
24vcc 200W 2500 RPM
Ø 77,30cw/ccw



TR 1047

Motor imã permanente
H50 24vcc 300W
2900 RPM
Ø 77,30cw/ccw



AT 1200

Motor imã permanente
24vcc 200W
2900 RPM 63B14
Ø 77,30cw/ccw



AT 1300

Motor imã permanente
24vcc 300W
2900 RPM 63B14
Ø 77,30cw/ccw



AT 1400

Motor imã permanente
260vcc 300W
2900 RPM 63B14
Ø 77,30cw/ccw



AT 1401

Motor imã permanente
150vcc 300W
2900 RPM 63B14
Ø 77,30cw/ccw



AT 1500

Motor imã permanente
260vcc 500W
2500 RPM 63B14
Ø 77,30cw/ccw



AT 1501

Motor imã permanente
150vcc 500W
2500 RPM 63B14
Ø 77,30cw/ccw



AT 1502

Motor imã permanente
24vcc 500W
2000 RPM 71B14
Ø 102cw/ccw



AT 1503

Motor imã permanente
260vcc 1400W
3200 RPM 71B14
Ø 102cw/ccw

MOVIMENTAÇÃO DE CARGA

Modelo
AT 2006



AT 2006

Transportador para 220Kg
L 550 P 400 - 4,76 - 1,5mm

Modelo
AT 2007



AT 2007

Transportador para 120Kg
L 450 P 400 - 3,18 - 1,2mm

Modelo
AT 2008



AT 2008

Transportador para 80Kg
L 400 P 300 - 3,18 - 1,2mm

Os Movimentadores de Cargas foram criados para facilitar o transporte manual em indústrias de todos os segmentos, estabelecimentos comerciais, empreendimentos imobiliários, residências, entre outros.

Fabricados em aço inoxidável 304 e alumínio de alta qualidade, são equipamentos criados para serem duráveis, leves e versáteis.

PRATICIDADE E INOVAÇÃO

Produzidos com sistema de bandeja removível, que possibilita a utilização de suportes personalizados para usos específicos. Deste modo é possível acoplar bandejas com suportes para cilindros de gás, caixas plásticas, mangueiras, fios, materiais de construção, entre outros.

Para desenvolver um acoplamento personalizado para sua utilização entre em contato com a equipe técnica Tryrex.

SERVIÇOS ESPECIALIZADOS DA TRYREX

Além de nossos diversos produtos, nós da Tryrex, oferecemos uma série de serviços para empresas que procuram qualidade e agilidade.

Somos referência na prestação de serviços como corte à laser de chapas, dobra de chapas CNC, usinagem CNC em torno e fresadora, solda MIG, solda TIG, solda Ponto, montagem de componentes e modelagem 3D.

Entre em contato conosco para saber mais informações dos serviços especializados.



USINAGEM CNC



CORTE À LASER
DE CHAPAS



DOBRA DE CHAPAS CNC





SOLDAS MIG, TIG
E PONTO



 **TRYREX**
www.tryrex.com.br

CONHEÇA
NOSSO SITE



-  @tryrexbrasil
-  54 3461-0309
-  54 99970-0751
-  Rua Buarque de Macedo, 5199 - Bairro Navegantes - Carlos Barbosa/RS



Todas as imagens contidas neste catálogo são meramente ilustrativas. A Tryrex se reserva no direito de efetuar alterações nos produtos, descrições e outros, sem aviso prévio. Catálogo atualizado em Junho de 2024.